

Data Sheet



Article number: 586142148

Description: Push-on fitting 14.214-8, metal $\text{Ø}8/6\text{-G } 1/4\text{'-Ø}8/6$
Banjo Tee

Measures

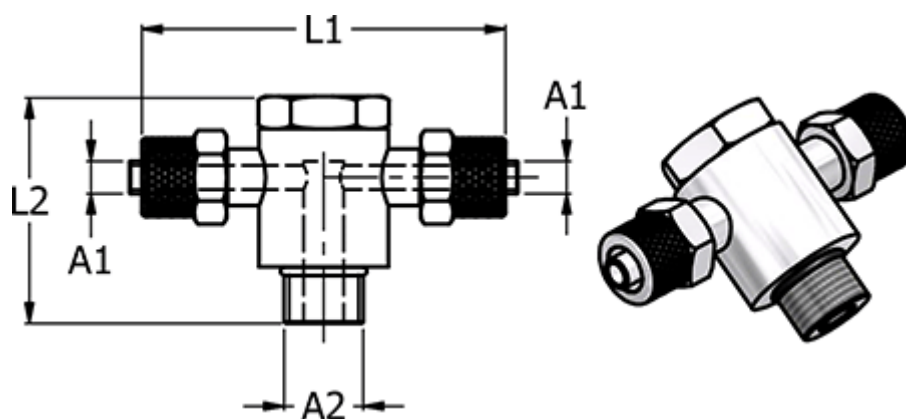

Hose diameter A1	= 8/6
L1	= 52.0
L2	= 33.0
NV	= 17
Thread A2	= G 1/4"